

Peak Emission Wavelength: 235nm

The MTSM2350HSF-UV is a powerful far UV-C emitting device. A peak wavelength of 235nm LED creates new feasibility for a variety of applications. This UV Emitter is in a Seam Welded Surface Mount package for applications requiring high output power and efficiency.

FEATURES

- > 5mm x 5mm Seam Welded Surface Mount Package
- > Hermetically Sealed Package
- > High Output Power
- > Silanna Safe

APPLICATIONS

- > UV Curing
- > Air and Water Disinfection
- > DNA Protein Analysis
- > Gas Sensing

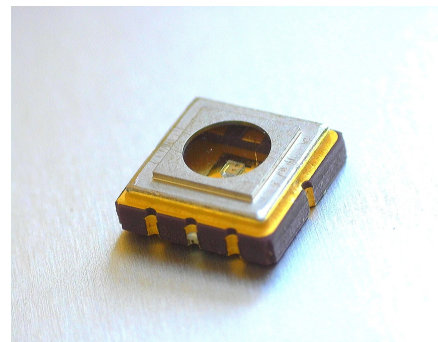

Absolute Maximum Ratings (Ta=25°C)



ITEMS	SYMBOL	RATINGS	UNIT
Forward Current	IF	100	mA
Reverse Voltage	VR	TBD	V
Power Dissipation	PD	800	mW
Operating Temperature	Topr	TBD	°C
Storage Temperature	Tstg	-40 ~ +100	°C

Note: Also available on PCB - Starboard MTSM2350HSF-UV2 (See Page 3)

Electrical & Optical Characteristics (Ta = 25°C)

ITEMS	SYMBOL	CONDITIONS	MIN.	TYP	MAX.	UNIT
Forward Voltage	VF	IF=20mA	--	5.8	--	V
Peak Wavelength	λ_p	IF=20mA	--	237	--	nm
Radiant Flux	PO	IF=20mA	--	350	--	uW
FWHM	$\Delta\lambda$	IF=20mA	--	10	--	nm
View Angle	Θ	IF=20mA	--	120	--	deg

Package Dimensions

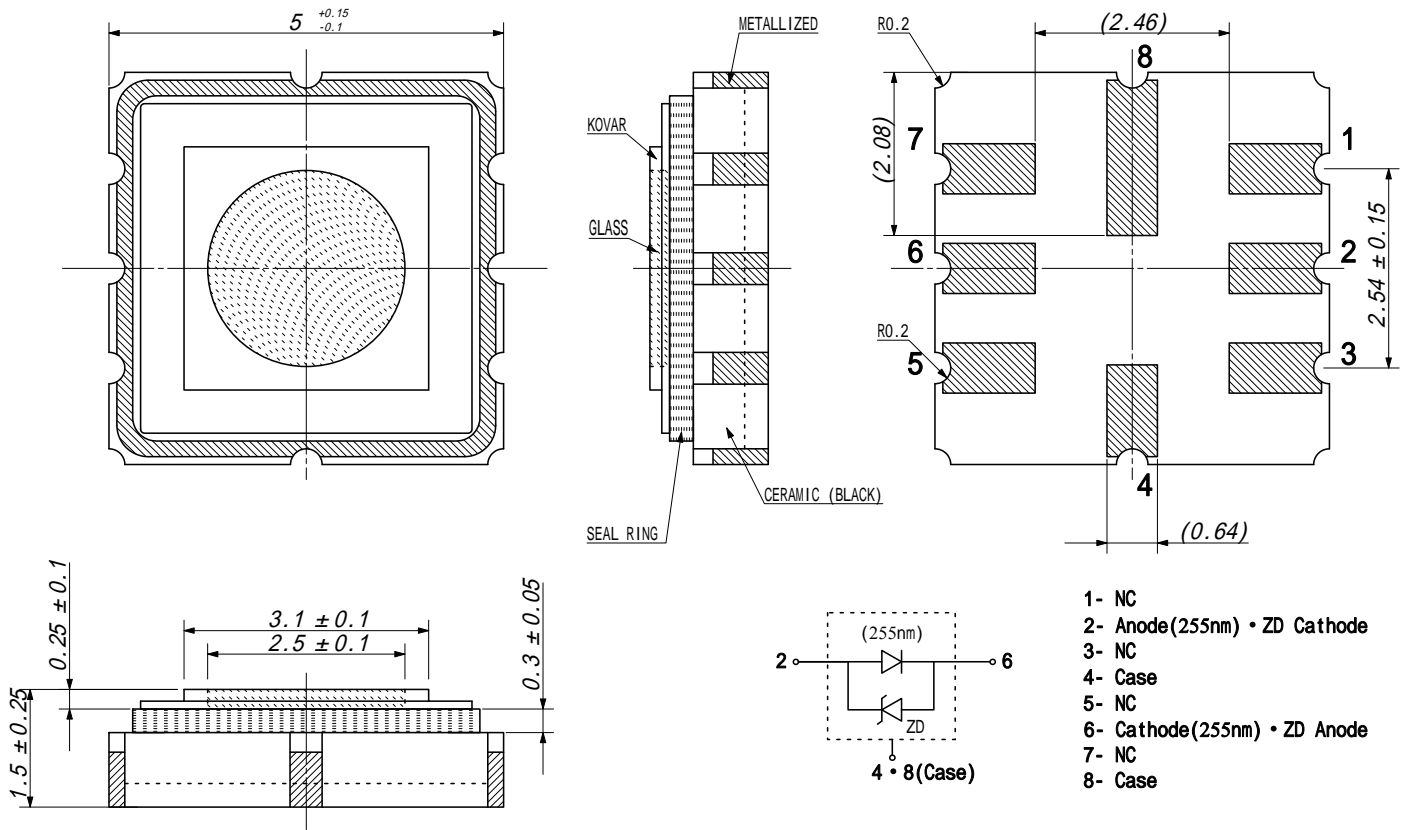

Recommended Soldering Pattern [mm]

Reflow Soldering Temperature-Profile [Pb free Soldering] (Recommend condition)

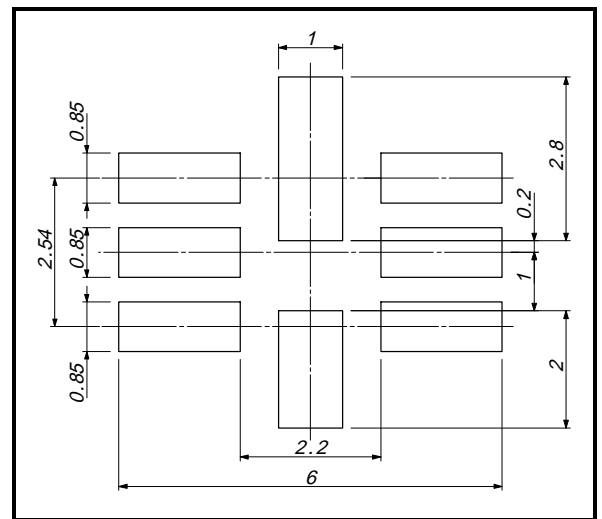
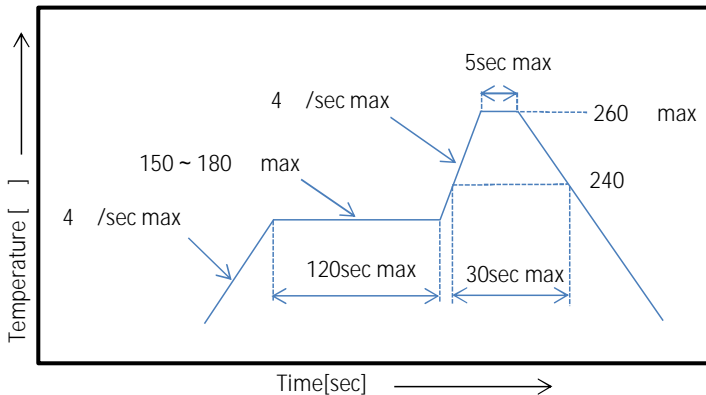

Starboard Dimensions

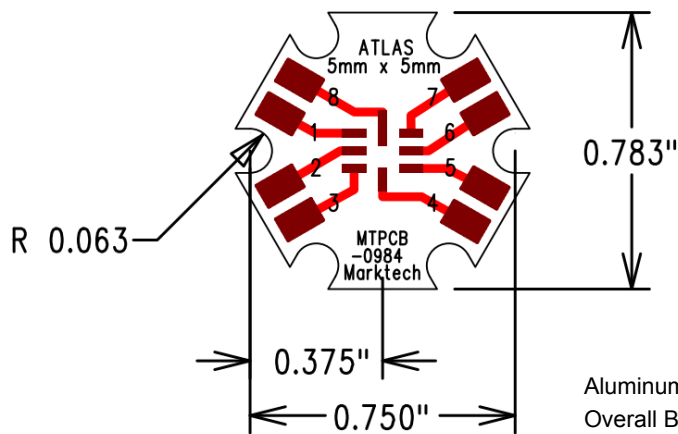

Pin 1	NC
Pin 2	Anode
Pin 3	NC
Pin 4	Case
Pin 5	NC
Pin 6	Cathode
Pin 7	NC
Pin 8	Case

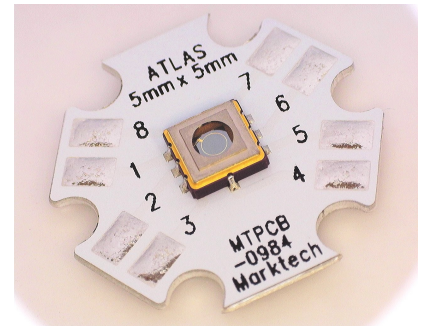

Aluminum Core Board 0.040" (1.02mm) Thickness
Overall Board Dimensions: +/- 0.010" (0.254mm)



We reserve the right to make changes to improve technical design and may do so without further notice. Parameters can vary in different applications. All operating parameters must be validated for each customer application by the customer.

The information contained herein is subject to change without notice.

2024-02-16

Spectral Response

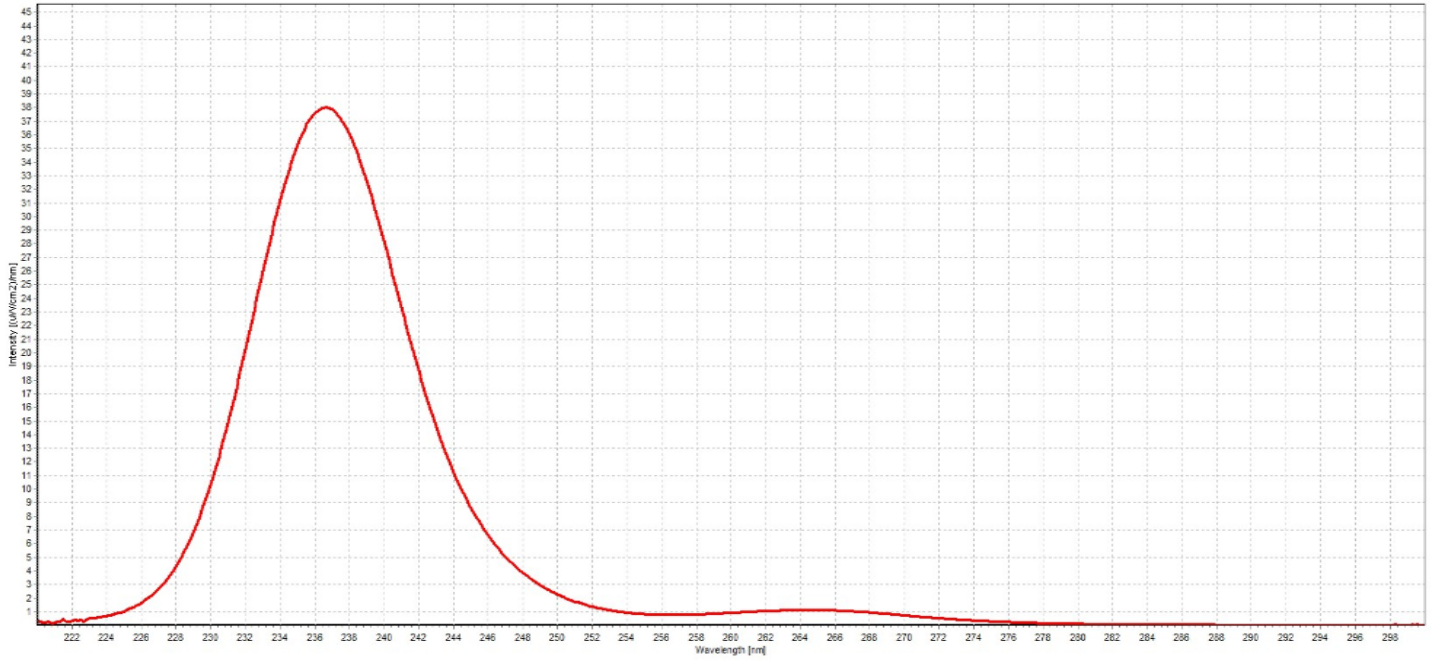

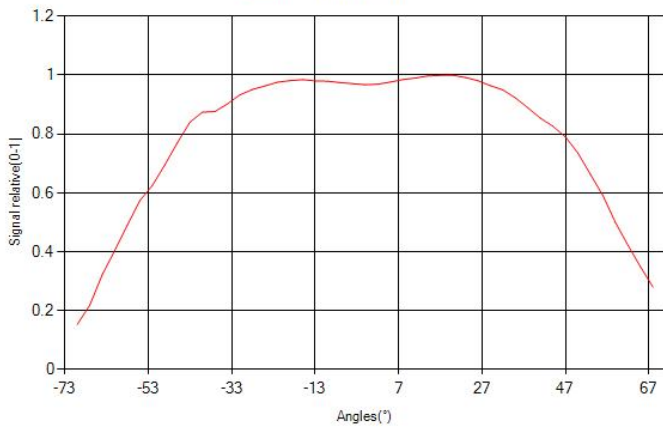

Radiation Distribution

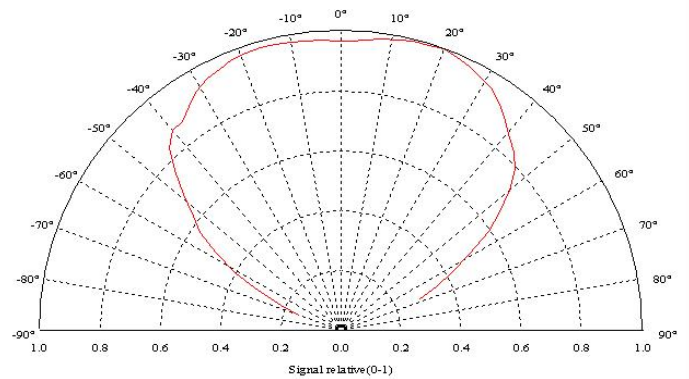

View Angle

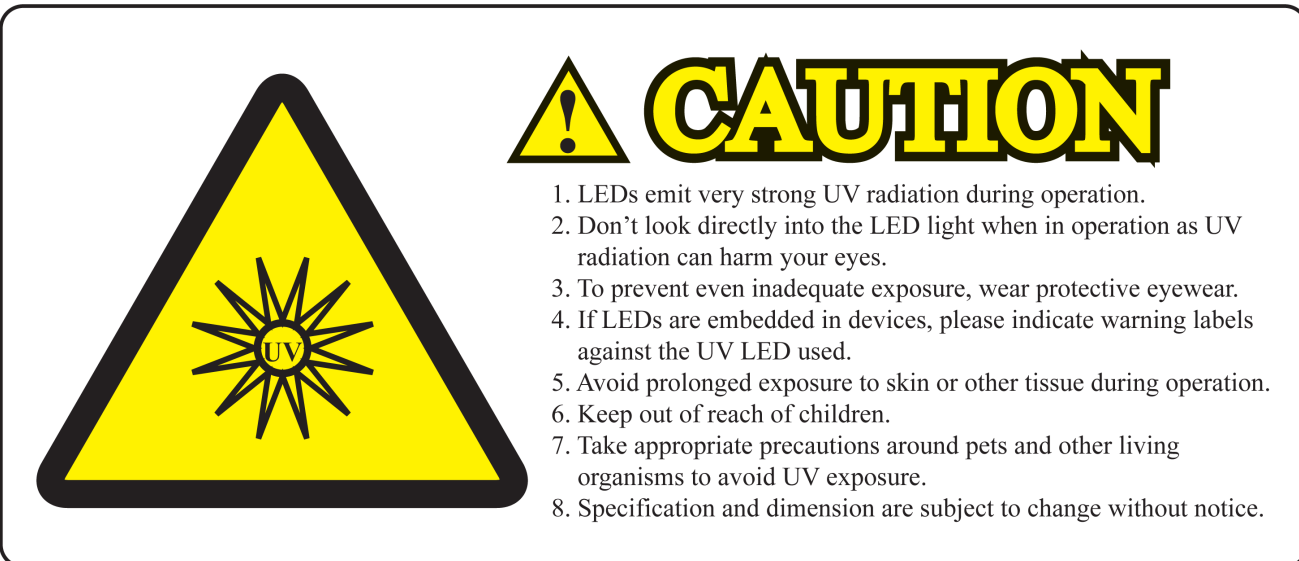



 **CAUTION**

1. LEDs emit very strong UV radiation during operation.
2. Don't look directly into the LED light when in operation as UV radiation can harm your eyes.
3. To prevent even inadequate exposure, wear protective eyewear.
4. If LEDs are embedded in devices, please indicate warning labels against the UV LED used.
5. Avoid prolonged exposure to skin or other tissue during operation.
6. Keep out of reach of children.
7. Take appropriate precautions around pets and other living organisms to avoid UV exposure.
8. Specification and dimension are subject to change without notice.